

Innovative Carport Carport FII Series

A new style carport with high design and functionality.

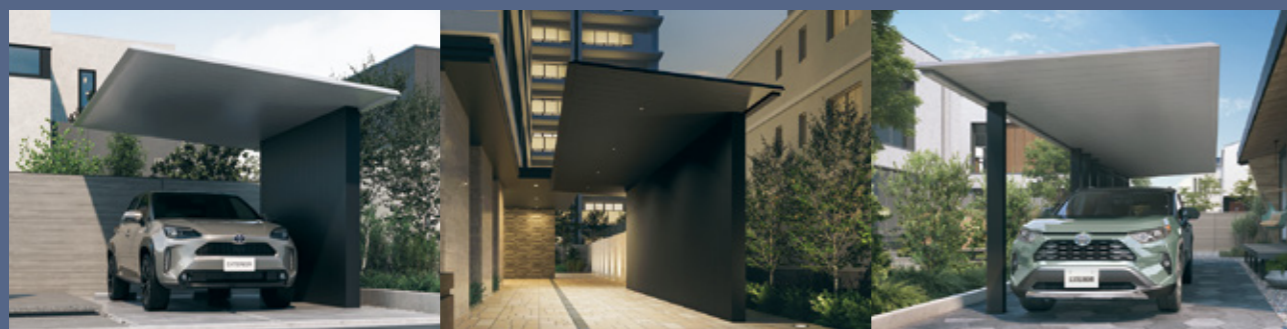

X(cross)-style Series

The combination of carport and screen creates a high-quality space with a variety of fit and high design.



SCN Series

Strong for stormy wind and heavy snow.



Manufacturer:

Sankyo Tateyama, Inc.
SankyoAlumi-Company

Exterior Division Home Material Department
Address: 70 Hayakawa, Takaoka, Toyama 933-8610, Japan
Homepage: <http://www.exteriorworld.jp/english/>



General sales agency:

TOYO Boeki Co., Ltd.

Address : 5-3-7 Fukushima, Fukushima-ku,
Osaka 553-0003, Japan

Tel : +81-6-6452-3839

Fax : +81-6-6452-3827

E-mail : eigyobu@toyoboeki.co.jp

Homepage: <http://www.toyoboeki.co.jp>
<http://www.carport-japan.jp>



ISO 9001
ISO 14001



JTCCM
QS/EMCA
RQ 2063, RE 0695

(Registration range) <http://www.exteriorworld.jp/english/>



Catalog No.
STX1791A
X.24.05-070

Printed in Japan

SankyoTateyama

Aluminum Exterior Products Series Catalog



Made in Japan



Perfect for parking space and entertaining areas
 Architecturally designed for style and function

Premium Focus

No one desires inferior products. No one desires continual maintenance costs for products they've already paid for either. This is why we only use premium quality materials to deliver premium quality results.

Carport

▶ P.3



PJR-Series



PJF-Series



MLR-Series



LJF-Series



VR/VRS-Series



VD/VDS-Series



RSC/RSZ-Series



ATLD-Series



USN-Series

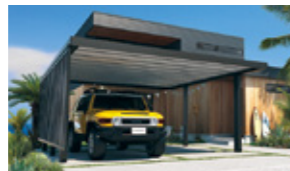

SKC-Series



KWC-Series



KLB/KLBS-Series

Terrace & Patio Covers

▶ P.29



TR-Series



TF-Series

Entry Gate & Tall Gate

▶ P.33



MCE-Series



Boundary Fence and Tall Fence

▶ P.35



CEF-Series



Non-Caster Accordion Gates

▶ P.37



HGN-Series



PORT VARIATION

Designed Port well harmonized design and function.

Many size variations for various spaces and lifestyles. Strong components and high resistance for wind and snow. Easy installation and maintenance.



PJR-Series



Carport for various lifestyles with excellent performance.

► P.5

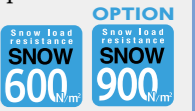

PJR

PJF-Series



Refined simple & flat design.

► P.7

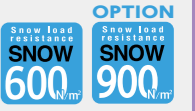

PJF

MLR-Series



Port with risers with reversed roof-slope option.

► P.11

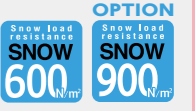

MLR

LJF-Series



Redesigned open roof structure delivers beauty and strength.

► P.13



LJF

VR/VRS-Series



Higher grade model for wind and snow.

► P.15



VR/VRS

VD/VDS-Series



Beautiful curved edge protects your car from wind and snow.

► P.16



VD/VDS

RSC/RSZ-Series



Front open, a clear view and easy access for parking.

► P.17



RSC/RSZ

ATLD-Series



Strong structure and beautiful design improves quality living.

► P.19



ATLD

USN-Series



Entrance / Carport system creates the perfect entrance space.

► P.21



USN

SKC-Series

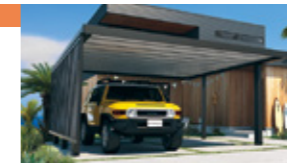

Sophisticated flat carport with a focus on strength and design.

► P.23



SKC

KWC-Series



Cantilever design with deep projection. Post can be positioned on side or back.

► P.25



KWC

KLB/KLBS-Series



Small port with side panels for EV charger or bicycles.

► P.26



KLB/KLBS



Single Basic
 × 1 car

PJR-5033 H23 (SLC)



Wide Beam Triple
 × 3 cars

PJRT-5072 H23 (BD)



× 2 cars

× 2 cars

× 2 cars



× 1 car +

× 2 cars

ALUMINIUM COLOR



ROOF COLOR

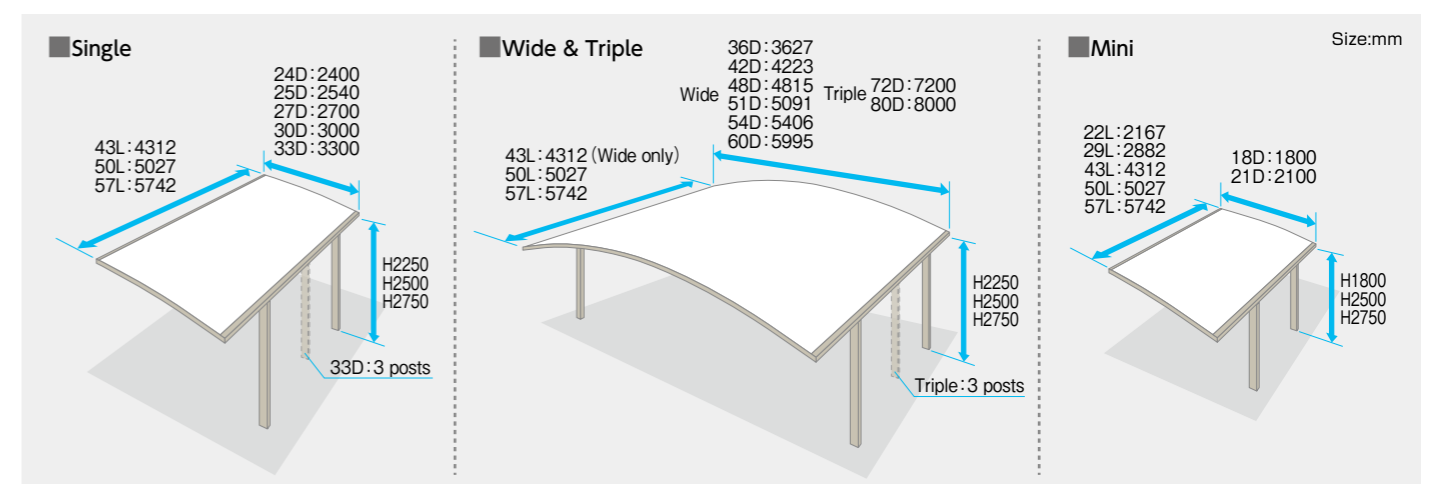
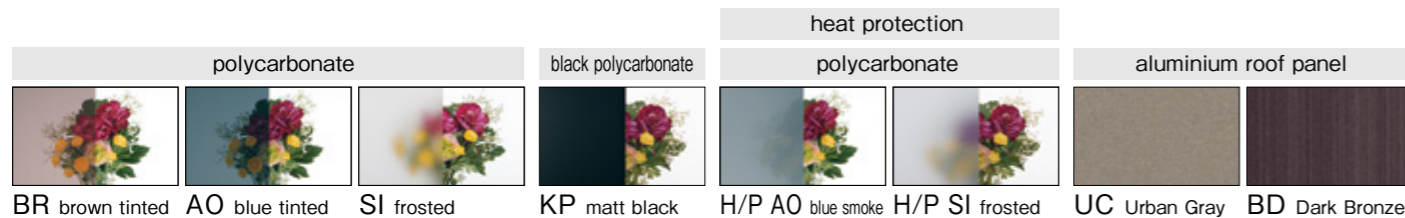



Single Basic

1 car

PJF-5127 H25 (UC)



Single Basic 33D

1 car

PJF-5133 H25 (KC)



Single Basic

M-Connection

Y-Connection



PJF-5127 H25 (UC)



PJF-51-2727M H25 (UC)



PJF-51-2727Y H25 (SLC)

1 car

2 cars

2 cars



In-Line Connection

In-Line Short Extension

Mini



PJF-5151-27 H25 (BD)



PJF-5114-27 H25 (SLC)



PJF-2921 H25 (UC)

2 cars

1 car + bicycle

bicycle

ALUMINIUM COLOR



SLC Sun Silver

UC Urban Gray

BD Dark Bronze

KC Black

WH White

BR Bronze

ROOF COLOR

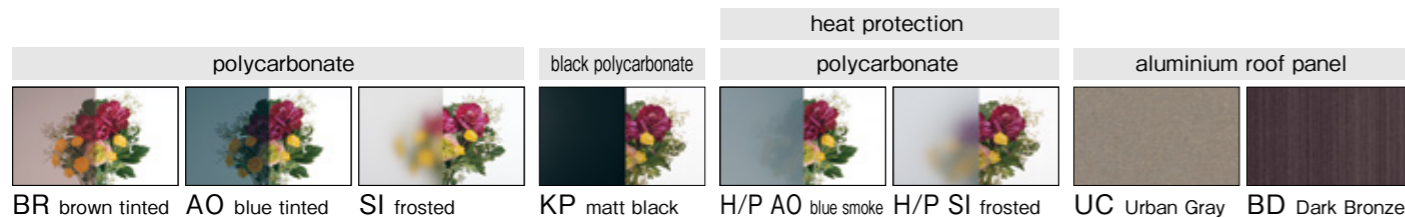

BR brown tinted

AO blue tinted

SI frosted

KP matt black

H/P A0 blue smoke

H/P SI frosted

UC Urban Gray

BD Dark Bronze

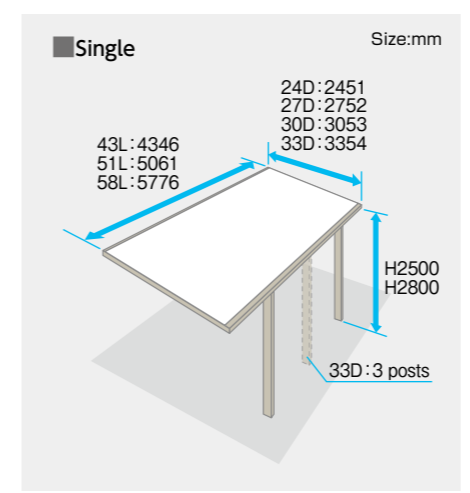

DESIGN

FLAT ROOF DESIGN

Simple & Stylish Form



PJR & PJF Series Common Features

Size

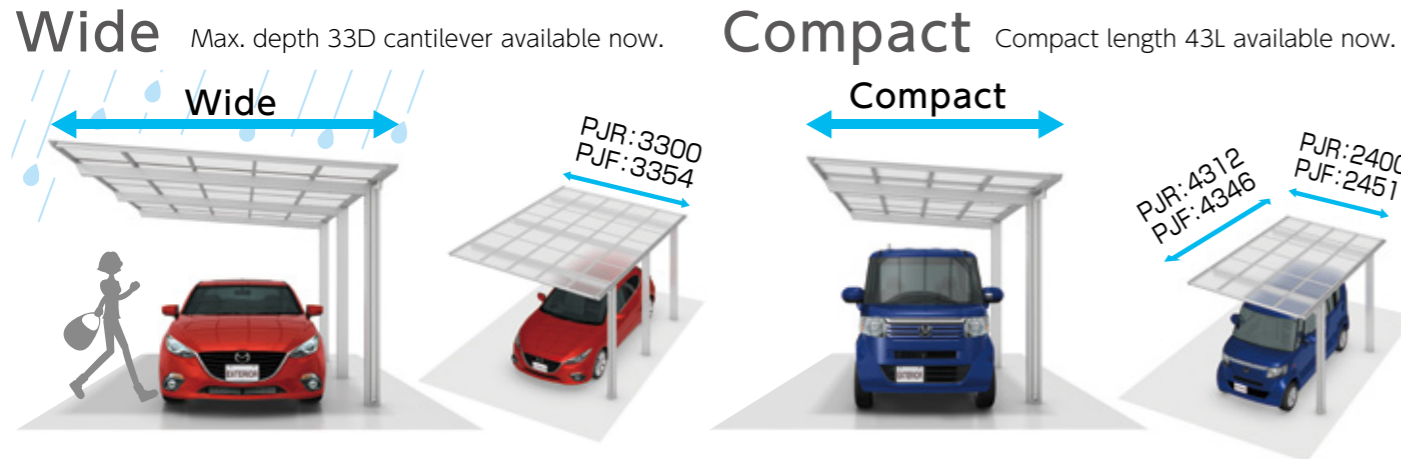

Post Type

PJR Series 3 different long post types H23, H25, H28 are available.

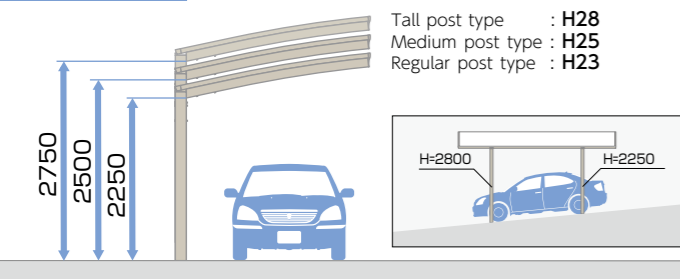

PJF Series 2 different long post types H25, H28 are available.

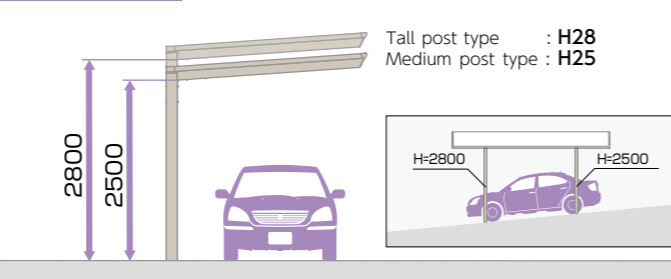

ALUMINIUM COLOR

6 color variations to match the style of your home.



ROOF COLOR

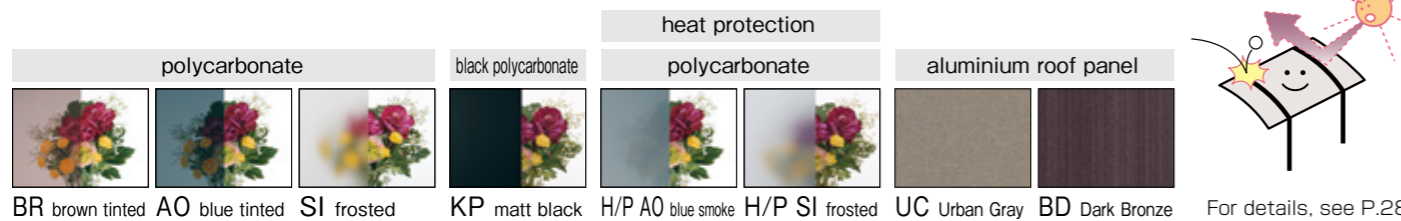

Locking Bolt

Common Screws

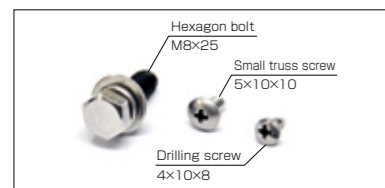

3 types of screws help save time during installation.

Protect Cushion

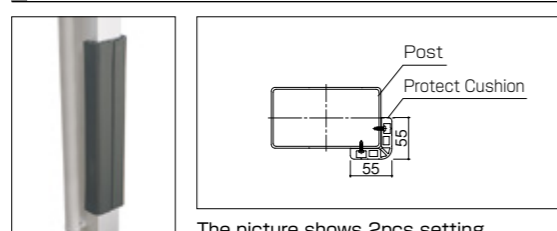

The picture shows 2pcs setting. The rubber cushion protects car-door and post while getting in/out the car.

Aluminium Down-spout

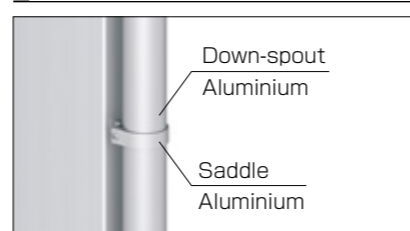

Aluminium rain gutter and saddle.

PJR & PJF Series Side-panel Options

Side Panel

PJR Series



Notes-1 Not available for ports with tall posts H28 (H=2.8m).
Notes-2 Requires an additional support post for side panels higher than H800, and panel support to achieve higher wind rating.

PJF Series



Notes-1 Not available for ports with tall posts H28 (H=2.8m).
Notes-2 Requires an additional support post for side panels higher than H800, and panel support to achieve higher wind rating.

PJR, PJF & MLR Series Options to protect from Wind and Snow

Wind & Snow Upgrade Package

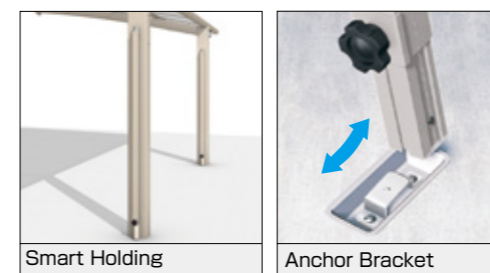
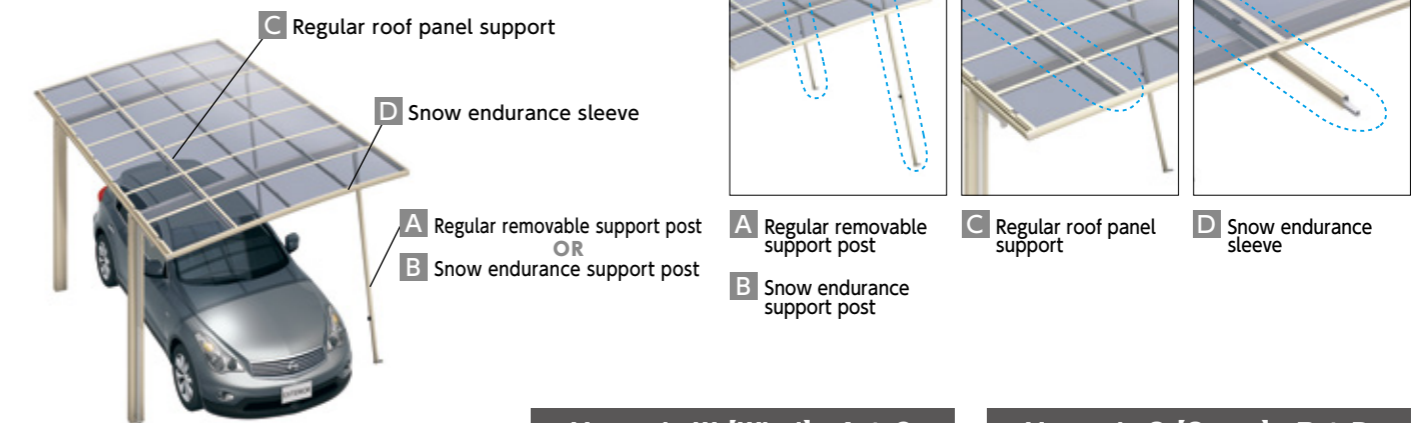

Smart Holding: Anchors rest attached to post, when not in use.
Anchor Bracket: Anchor floor bracket is recessed and has its own footing.

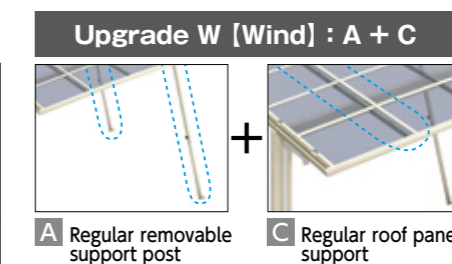

Upgrade W [Wind] : A + C

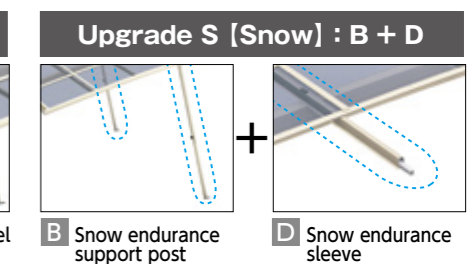

Upgrade S [Snow] : B + D

SNOW 20cm → 30cm Snow load resistance

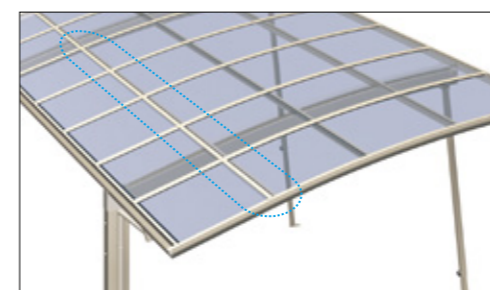

Roof panel support reinforces the roof panels against strong wind to ensure the safety of the carport.

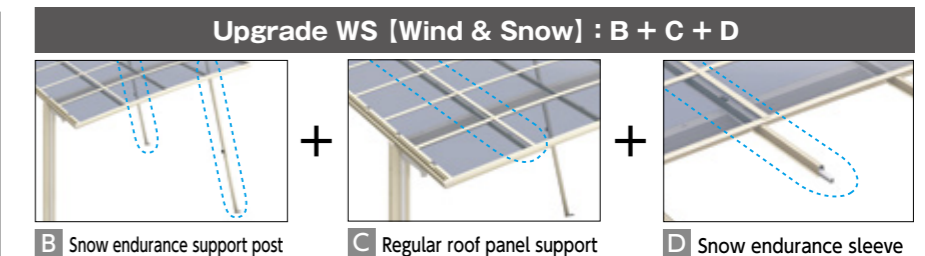

Upgrade WS [Wind & Snow] : B + C + D

SNOW 20cm → 30cm Snow load resistance

Smart & flat design, a beautiful addition to any modern house.



Single Basic
 × 1 car

MLR-5126 H25 (SLC)



Single Basic 34D
 × 1 car

Reverse Incline Roof
 MLR-R5134 H25 (KC)

M-Connection	In-Line Connection	In-Line Short Extension
MLR-51-2626M H25 (FAL)	MLR-5151-26 H22 (UC)	MLR-R5114-26 H25 (FAL)
× 2 cars	× 2 cars	× 1 car +

Mini

MLR-2922 H25 (YCL)

Reversible Roof Incline (Option)

- Standard Incline Roof Type
- Reverse Incline Roof Type

Reverse

COLOR

aluminium type				laminiate type							
SLC Sun Silver	UC Urban Gray	BD Dark Bronze	KC Black	FA Trad Oak	SLC Sun Silver	YC Craft Cherry	SLC Sun Silver	FA Trad Oak	UC Urban Gray	YC Craft Cherry	UC Urban Gray
				FAL		YCL		FAU		YCU	

ROOF COLOR

polycarbonate			black polycarbonate	heat protection polycarbonate	
BR brown tinted	AO blue tinted	SI frosted	KP matt black	H/P AO blue smoke	H/P SI frosted

Single Basic

Height: H2500 (H2800), Depth: 150

25D: 2839 (3139)
 26D: 2850 (3150)
 28D: 2860 (3160)
 31D: 2881 (3181)
 34D: 2903 (3203)

25D: 2523 26D: 2664
 28D: 2824 31D: 3125
 34D: 3426

M-Connection

Height: H2500 (H2800), Depth: 150

50D: 5081 52D: 5222 53D: 5363-5382
 55D: 5523 56D: 5683 58D: 5824 59D: 5984
 61D: 6125 62D: 6285 65D: 6586 68D: 6887

43L: 4356 (6 roof panels)
 51L: 5071 (7 roof panels)
 58L: 5786 (8 roof panels)

Reverse Incline Roof

Height: H2500 (H2800), Depth: 150

25D: 2797 (3097)
 26D: 2804 (3104)
 28D: 2812 (3112)
 31D: 2828 (3128)
 34D: 2843 (3143)

25D: 2537 26D: 2677
 28D: 2836 31D: 3134
 34D: 3432

Mini

Height: H2500 (H2800), Depth: 150

19D: 2797 (3097)
 22D: 2818 (3118)

19D: 1919 22D: 2221

22L: 2211 (3 roof panels)
 43L: 4356 (6 roof panels)
 58L: 5786 (8 roof panels)

29L: 2926 (4 roof panels)
 51L: 5071 (7 roof panels)



The Redesigned LJF has an open roof structure combining beauty and strength. Protects from sun, wind and rain.





Single Basic	Wide Beam Triple	In-Line Connection
 LJF-5028 H23 (UC)	 LJF-5080 H23 (BD)	 LJF-5050·28 H23 (YCU)
 × 1 car	 × 3 cars	 × 2 cars

Single (Bearing Beam)	Wide Beam	Advantage of single long slope
 LJF-5028 H23 (YCK)	 LJF-5054 H23 (FAU)	 Protect wind blow and rain! Keep fine view from inside! Enough length to suit your car
 × 1 car	 × 2 cars	

COLOR

														
aluminium type	laminated type													
<table border="1"> <tr> <td>SLC Sun Silver</td> <td>UC Urban Gray</td> <td>BD Dark Bronze</td> <td>KC Black</td> <td>WH White</td> <td>KC Black</td> <td>SLC Sun Silver</td> </tr> </table>	SLC Sun Silver	UC Urban Gray	BD Dark Bronze	KC Black	WH White	KC Black	SLC Sun Silver	<table border="1"> <tr> <td>FA Trad Oak</td> <td>UC Urban Gray</td> <td>YC Craft Cherry</td> <td>UC Urban Gray</td> <td>YC Craft Cherry</td> <td>KC Black</td> </tr> </table>	FA Trad Oak	UC Urban Gray	YC Craft Cherry	UC Urban Gray	YC Craft Cherry	KC Black
SLC Sun Silver	UC Urban Gray	BD Dark Bronze	KC Black	WH White	KC Black	SLC Sun Silver								
FA Trad Oak	UC Urban Gray	YC Craft Cherry	UC Urban Gray	YC Craft Cherry	KC Black									
KLC	FAU YCU YCK													

ROOF COLOR

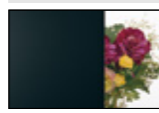
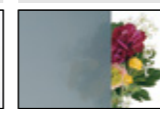
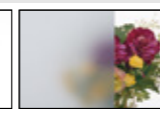
polycarbonate			black polycarbonate	heat protection polycarbonate		
						
BR brown tinted	AO blue tinted	SI frosted	KP matt black	H/P AO blue smoke	H/P SI frosted	

Cantilever Type

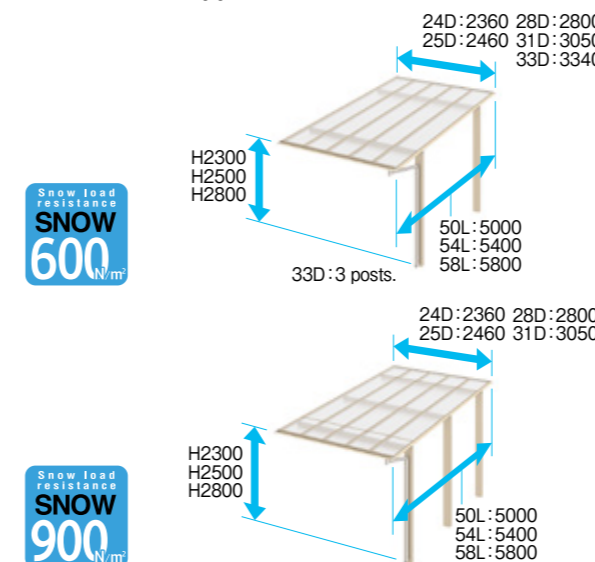

Bearing Beam Type

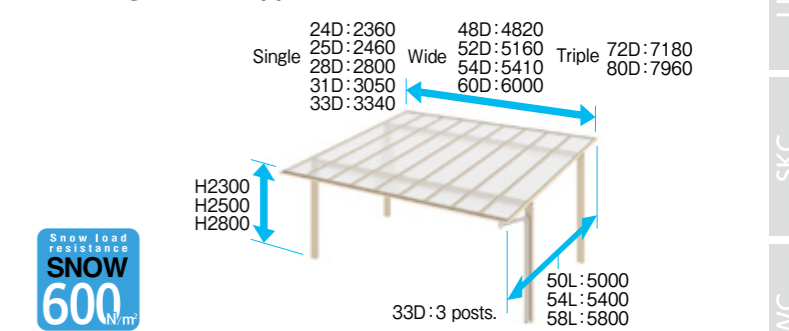

Two ports with various options for snow-loads and higher wind-ratings.



Single Basic
 × 1 car

VR-5027 H23 (SLC)



Single Basic
 × 1 car

VD-5127 H23 (UC)



× 2 cars

ALUMINIUM COLOR

SLC Sun Silver UC Urban Gray BKC Dark Bronze

STRENGTH

VR-series (2posts type) **SNOW 900** N/m²

VRS-series (3posts type) **SNOW 1500** N/m²

ROOF COLOR

polycarbonate black polycarbonate heat protection polycarbonate

AO blue tinted SI frosted KP matt black H/P AO blue smoke H/P SI frosted

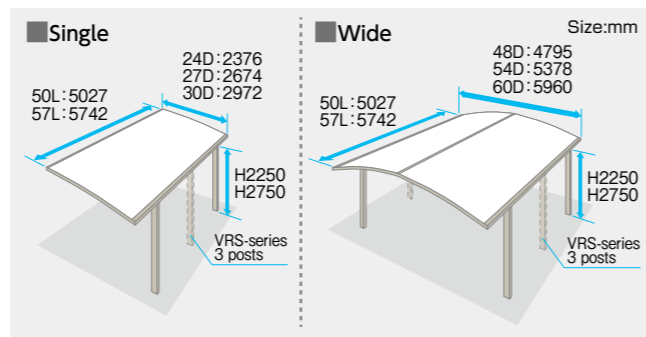

× 2 cars

ALUMINIUM COLOR

SLC Sun Silver UC Urban Gray BKC Dark Bronze

STRENGTH

VD-series (2posts type) **SNOW 900** N/m²

VDS-series (3posts type) **SNOW 1500** N/m²

ROOF COLOR

polycarbonate heat protection polycarbonate

AO blue tinted SI frosted H/P AO blue smoke H/P SI frosted

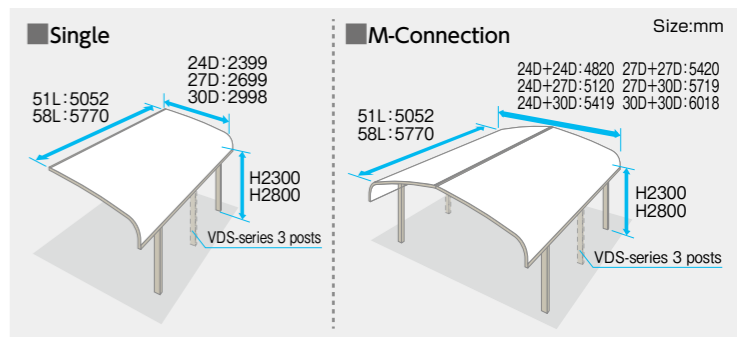

Front open, a clear view and easy access for parking.



RSC Series
Single
1 car
RSC-5027 H23 (KC)



RSZ Series
Wide
2 cars
RSZ-5054 H23 (FAL)



COLOR

aluminium type			laminate type			
SLC Sun Silver	UC Urban Gray	KC Black	FA Trad Oak	SLC Sun Silver	YC Craft Cherry	SLC Sun Silver
FAL			YCL		FAU	
			YCU			

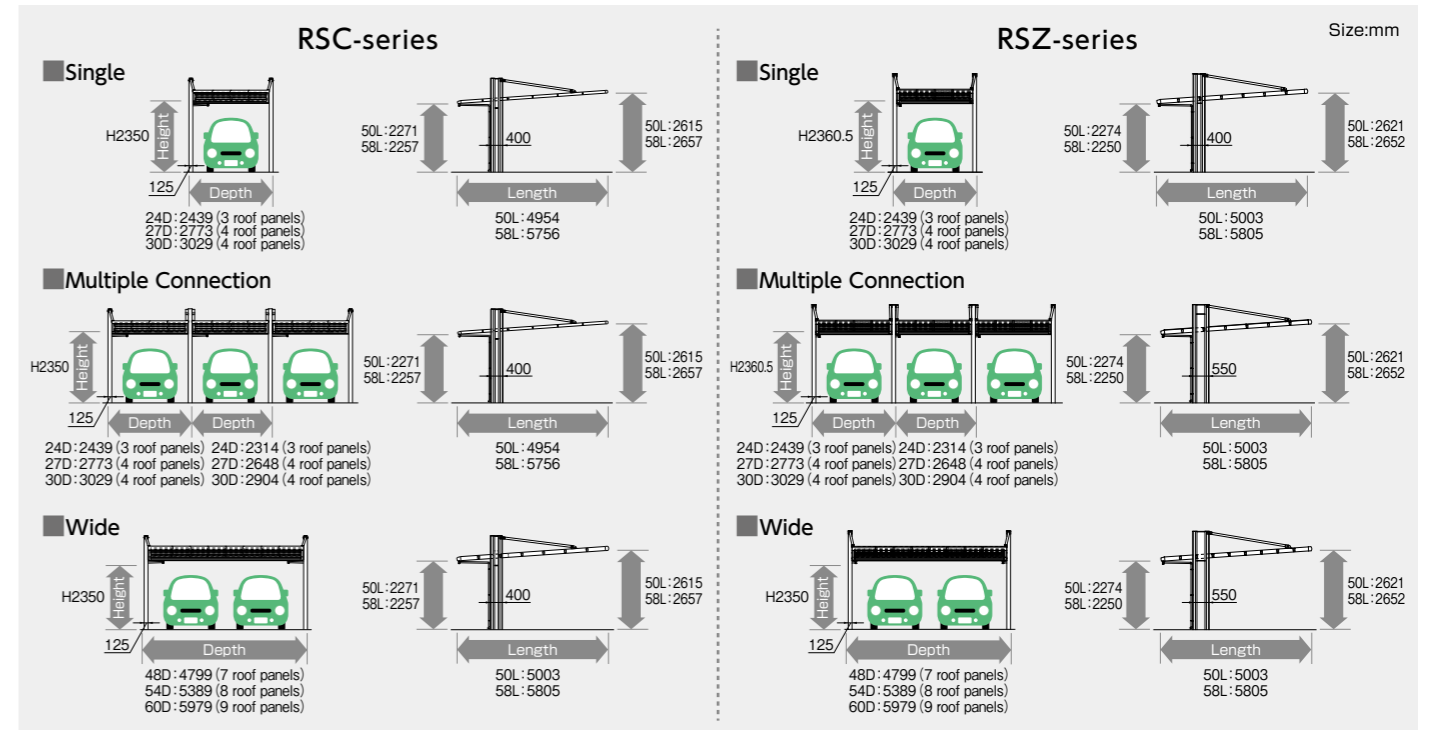
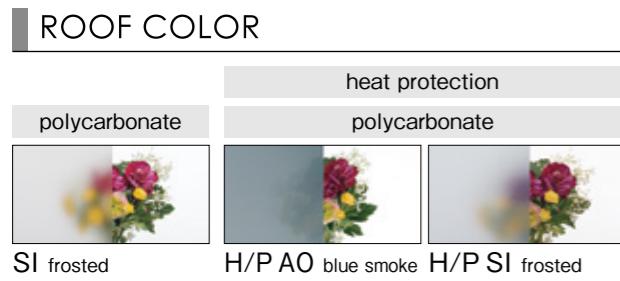



Wide
 × 2 cars

ATLD-5558 H25 (UC·HG)



Product video



× 1 car

× 2 cars

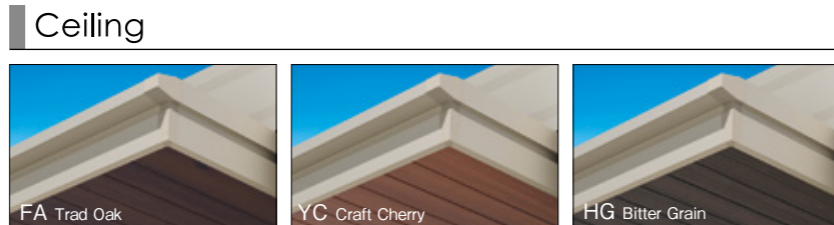
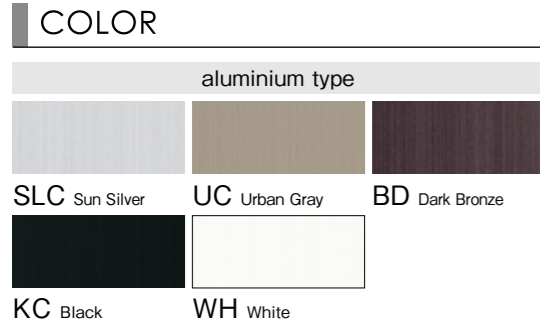

PJR
 PJF
 MLR
 LJF
 VRVRS
 VD/VDS
 R5C/R5Z
 ATLD
 U5N
 SKC
 KWC
 KLB/KLB5

Entrance / Carport system creates the perfect entrance space.



Wide
 × 3cars

USN-60 (24-24-24) H26 (KC·YC)



× 2cars

× 2cars

COLOR

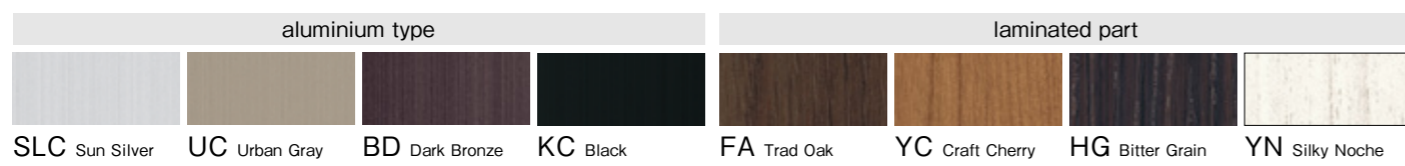

ROOF COLOR

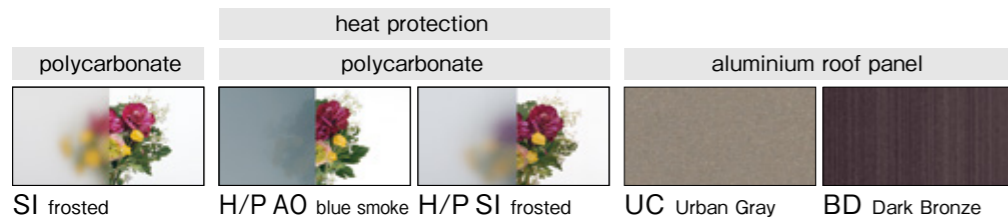

Roof style variations

Standard Roof

Aluminium roof frame



Wood-laminate roof frame



Premium Roof

Aluminium roof frame + Wood-laminate ceiling



Wood-laminate roof frame + ceiling



Select-line Roof

Aluminium roof frame

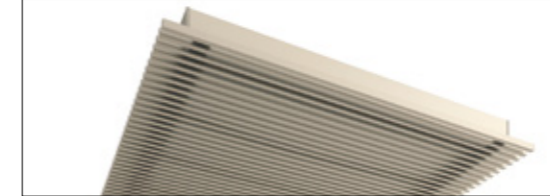

Wood-laminate roof frame + ceiling



Basic structure

Roof placed on beams



Roof suspended from beams



Size(mm)

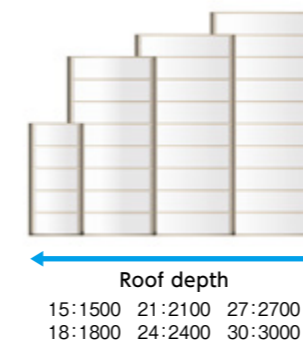

Ceiling

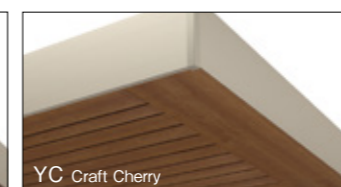



Wide
 × 2 cars

SKC-6155 H25 (KC)



Product video



× 2 cars

× 2 cars



ALUMINIUM COLOR / Ceiling

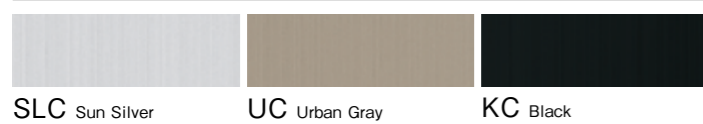

ROOF COLOR



Side panel

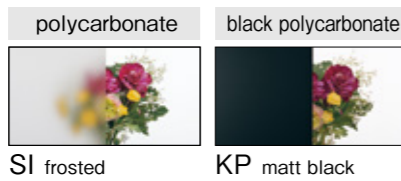

STRENGTH



Type

Standard Type (without ceiling)

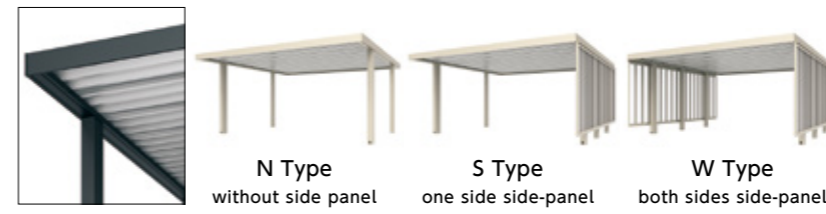

Premium Type (with ceiling)

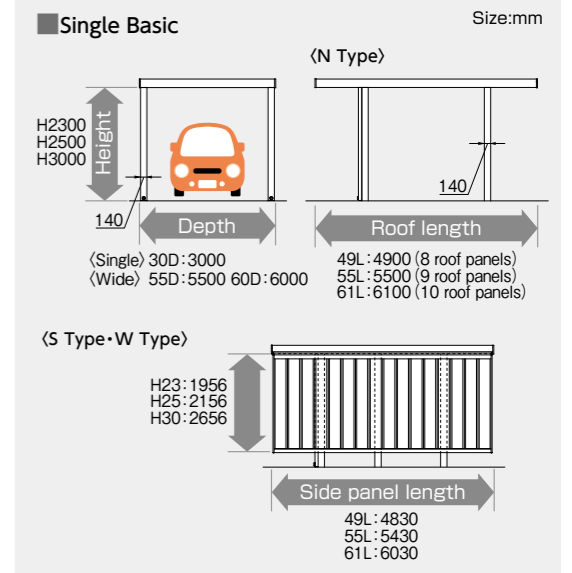
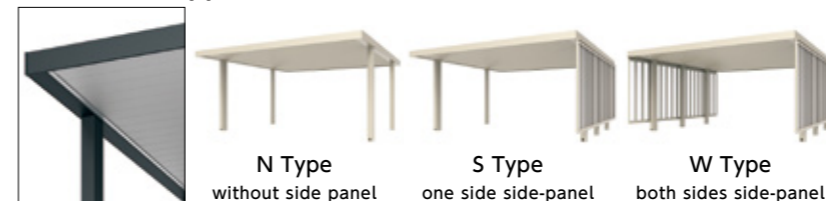

Cantilever design with deep projection.
Posts can be positioned on side or back.

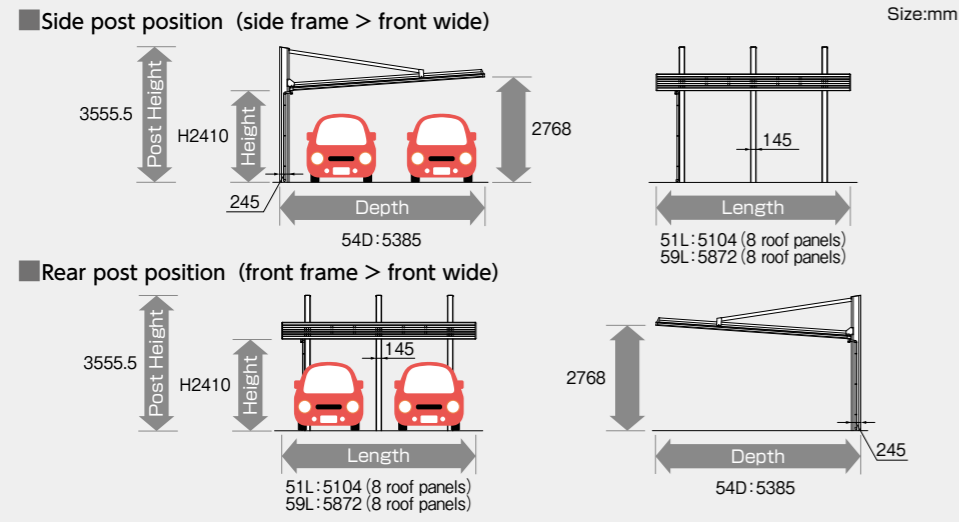

Side post position



Rear post position



COLOR



ROOF COLOR

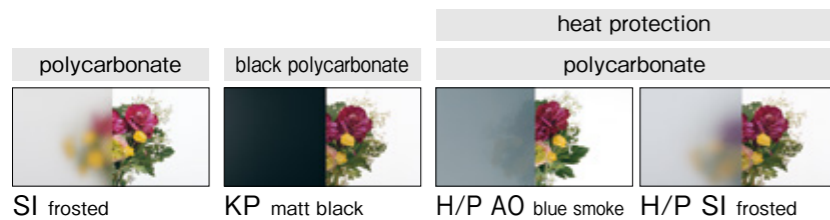

Small port with side panels for EV charger or bicycle.



Single side panel type

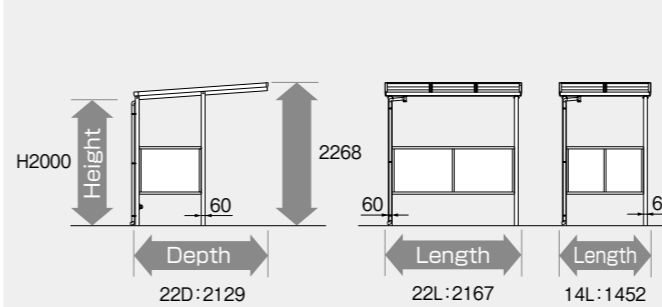

Double side panel type

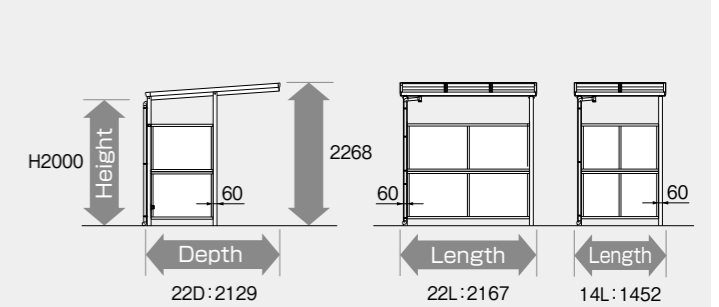

ALUMINIUM COLOR



ROOF COLOR

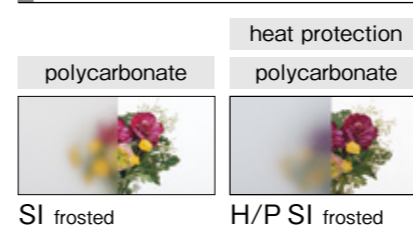

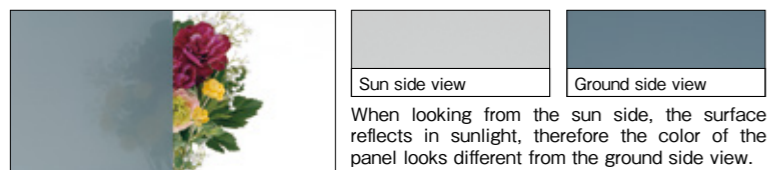

H/P AO blue smoke

Cuts out 83% of heat rays

Almost all harmful ultraviolet rays (UV) can be cut out. The roof protects car paintwork from fading and car seats from discoloring.

Cuts out 83% of heat rays

Cuts out 100% of UV rays

The temperature in sun-heated cars can rise to 65.8°C. Heat protection polycarbonate carports protect your cars from the summer heat.

CAR INSIDE -21°C

Polycarbonate roof protects your car from heat waves and restricts temperature rise in the car.

■ Effect of polycarbonate roof against heat wave (our test result)

Exposed to the sun	Under general polycarbonate roof	Under heat protection polycarbonate roof
65.8°C	50.5°C	44.1°C

The above values are actual values measured by us and not guaranteed values for the products.

Approx. 250 times stronger than glass

Polycarbonate sheet has impact resistance approx. 250 times higher than glass. It can even withstand being hit with a hammer. The polycarbonate roof can protect your car from bad weather conditions such as hail. In addition, since it does not harden, it is suitable for use in cold climates.

Model	PJR	PJF	MLR	LJF	VR/VRS	VD/VDS	RSC/RSZ	ATLD	USN	SKC	KWC	KLB/KLBS
Polycarbonate	Cut out UV rays 100% and has a strong impact resistance 250 times higher than glass. Since it does not harden at low temperatures, it is suitable for use in cold climates.											
BR brown tinted	●	●	●	●	●	●	●	●	●	●	●	●
AO blue tinted	●	●	●	●	●	●	●	●	●	●	●	●
SI frosted	●	●	●	●	●	●	●	● Side panel	●	● Side panel	●	●
Black polycarbonate	Non-transparent black polycarbonate suppress the rise in temperature inside the car.											
KP matt black	●	●	●	●	●	●	●	●	●	●	●	●
Heat protection polycarbonate	The panel effectively cuts solar heat rays (infrared rays) and UV rays.											
H/P AO blue smoke	●	●	●	●	●	●	●	●	●	●	●	●
H/P SI frosted	●	●	●	●	●	●	●	●	●	●	●	●
Aluminium roof panel	Aluminum alloy panels protect the car from direct sunlight and solar heat. Both surfaces are coated with a polyester resin baked-on coating.											
UC Urban Gray	●	●	●	●	●	●	●	●	●	●	●	●
BD Dark Bronze	●	●	●	●	●	●	●	●	●	●	●	●

Roof Panel Performance

Performance	Panel Type	Polycarbonate			Black Polycarbonate	Heat Protection Polycarbonate	
		Brown Tinted (BR)	Blue Tinted (AO)	Frosted (SI)	Matt Black (KP)	Blue Smoke (H/P AO)	Frosted (H/P SI)
Heat Rays (IR) Cut %		45%	40%	16%	72%	83%	70%
Visible Rays Transmissivity %		34%	20%	88%	0%	11%	76%
UV Rays Cut %		100%	100%	100%	100%	100%	100%

Heat Effect under the Sun Shine

Performance	Panel Type	Sun Direct	Polycarbonate (BR)	Black Polycarbonate	Heat Protection Polycarbonate (H/P AO)
Car inside		65.8°C	50.5°C	44.4°C	44.1°C
Steering wheel (surface)		85.6°C	60.4°C	44.6°C	48.2°C
Dashboard (surface)		92.7°C	66.5°C	45.2°C	50.4°C

Test Condition : JAPAN / Summer / Fine Day
Ambient Temperature : 34°C~36°C



Terrace & Patio Covers

TR Series

Curve: 3 different types are available.

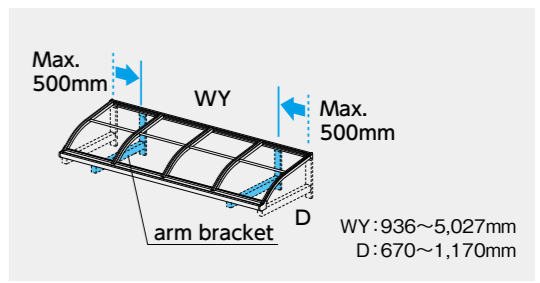
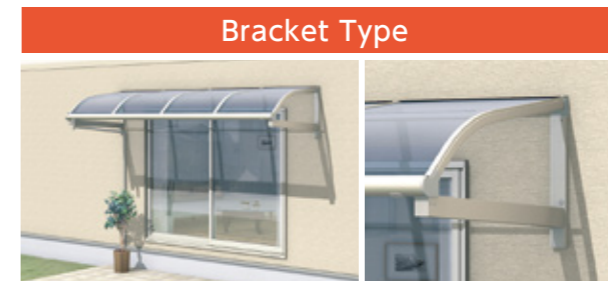
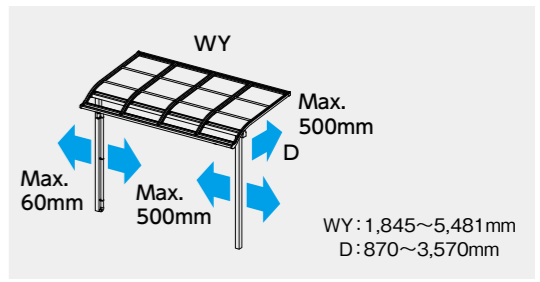
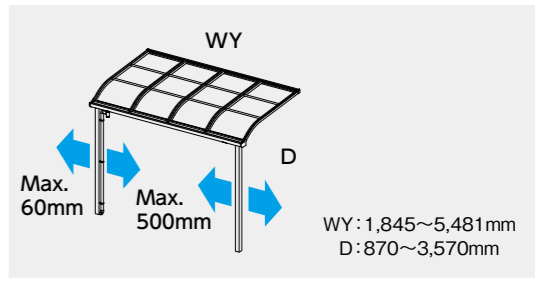
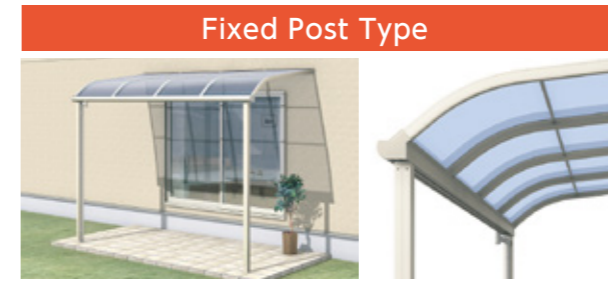

TF Series

Flat: 3 different types are available.

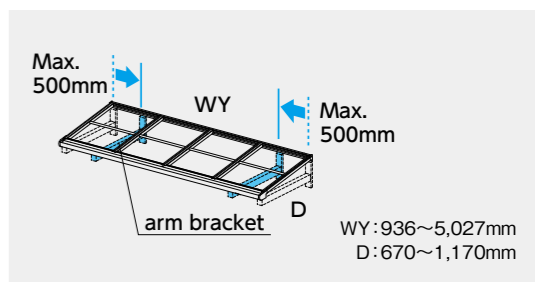
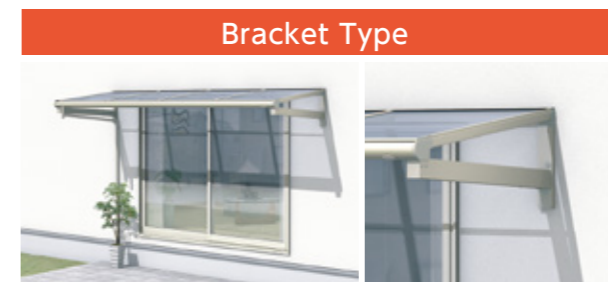
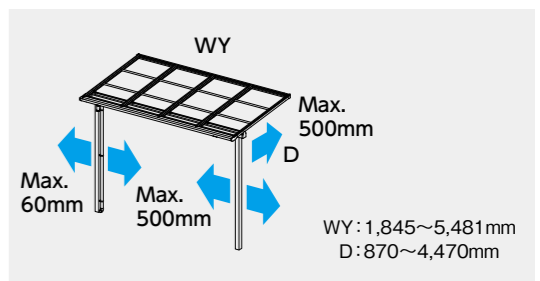
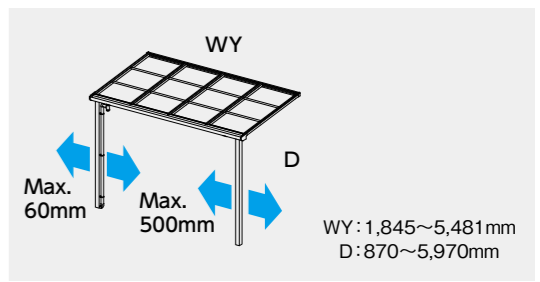

TR/TF
MCE
CFE
HGN



Installation Examples



Installation Examples



ALUMINIUM COLOR



ROOF COLOR



Option

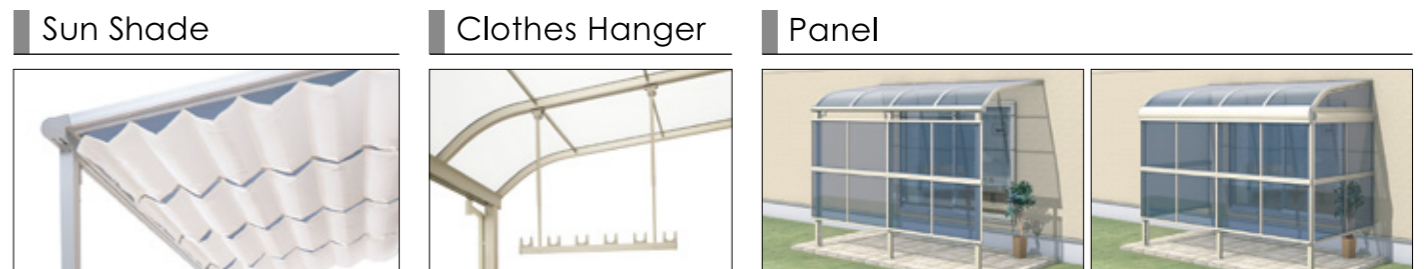

Projection: TR (Curve)



Projection: TF (Flat)

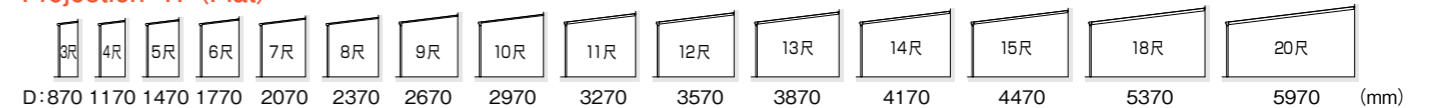

MCE Series Entry Gate & Tall Gate



Maximum Height is 2m (6.5ft) .
Maximum Width is 2.2m (7.2ft)
(for Double Gate)

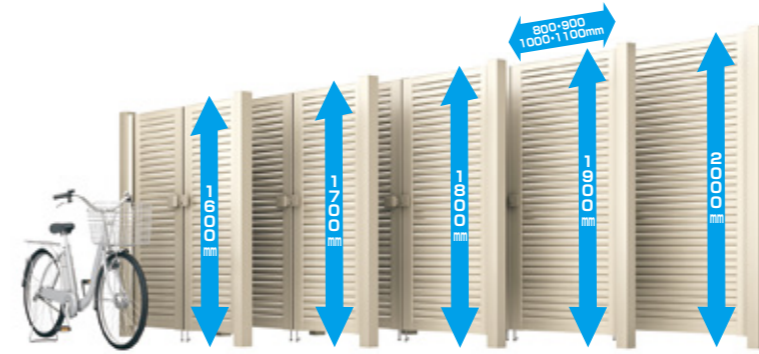

ALUMINIUM COLOR

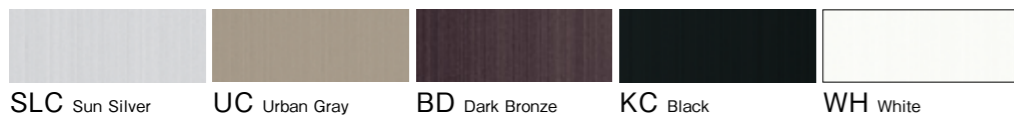

Single Gate

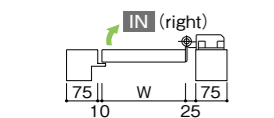

Double Gate

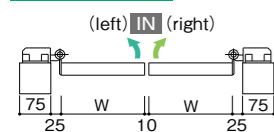

Dimensions (mm)

Height		Width																		
		Single Gate					Double Gate													
		600	700	800	900	1000	600x2	700x2	800x2	900x2	1000x2									
1000		○	○	○	○	—	○	○	○	○	○	○	○	○	○	○	○	○	○	○
1200		○	○	○	○	○	○	○	○	○	○	○	○	○	○	○	○	○	○	○
1400		—	○	○	○	○	—	○	○	○	○	○	○	○	○	○	○	○	○	○

● Bar Handle: MJN-CT (Thumb Turn)



▶ Product video

● Touch Handle: RJNT-CT (Thumb Turn)

● Touch Handle: RJNT-CC (Dimple Key)



▶ Product video

● Touch Bar Handle: RJNG-CT (Thumb Turn)



▶ Product video

ALUMINIUM COLOR

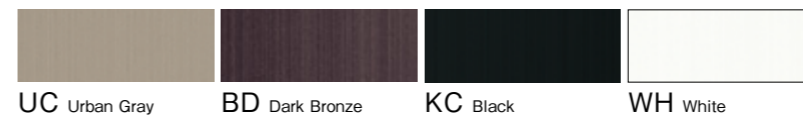

H Type

● Bar Handle: MJN-CT (Thumb Turn)



● Touch Handle: MJNT-CT (Thumb Turn)

● Touch Handle: MJNT-CC (Dimple Key)



● Touch Bar Handle: MJNG-CT (Thumb Turn)



HM Type

● Lever Handle: LMN-01 (Thumb Turn)

● Lever Handle: LMN-03 (Cylinder Key)

● Lever Handle: LMN-04 (Dummy Cylinder Key)



HK Type

● Keyless Entry Lock: MJN-KX-S



▶ Product video

Dimensions (mm)

Height		Width							
		Single Gate				Double Gate			
		800	900	1000	1100	800x2	900x2	1000x2	1100x2
1600		○	○	○	○*	○	○	○	○*
1700		○	○	○	○	○	○	○	○
1800		○	○	○	○	○	○	○	○
1900		○	○	○	○	○	○	○	○
2000		○	○	○	○*	○	○	○	○*

* indicates keyless entry lock gate size.



ALUMINIUM COLOR

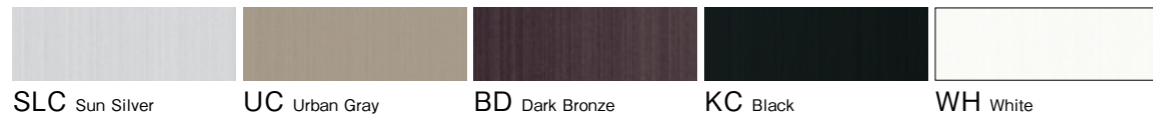

Corner Connector



In-Between Post Corner

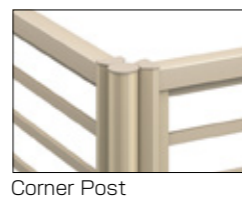

Free Post Type



In-Between Post



Many combinations of fence panel heights are available. Maximum height is 2936mm (9.6ft).

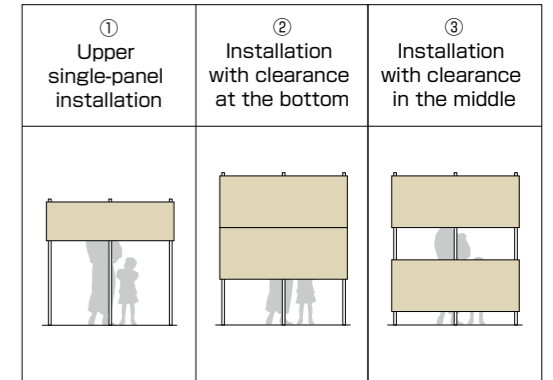

The fence panels can be installed at any height with adjustable brackets. You can combine different panel style and heights.



Top/bottom: YL2



Top/Middle: TM1/Under: TK1

ALUMINIUM COLOR

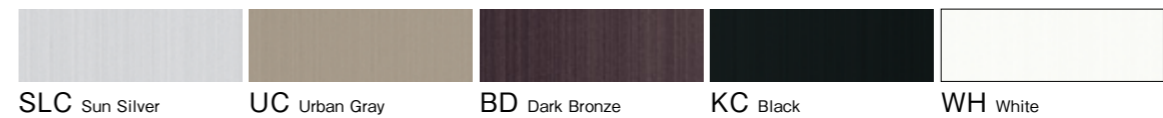

Basic Combination Size (mm)

	H06 H06	H08 H06	H08 H08	H10 H08	H10 H10	H12 H10	H12 H12	H10 H08 H08	H10 H10 H08	H10 H10 H10	Lower rail gap 80mm
	12	14	16	18	20	22	24	26	28	30	
Height	1123	1323	1523	1723	1923	2123	2323	2444	2644	2844	

HGN Series Non-Caster Accordion Gates

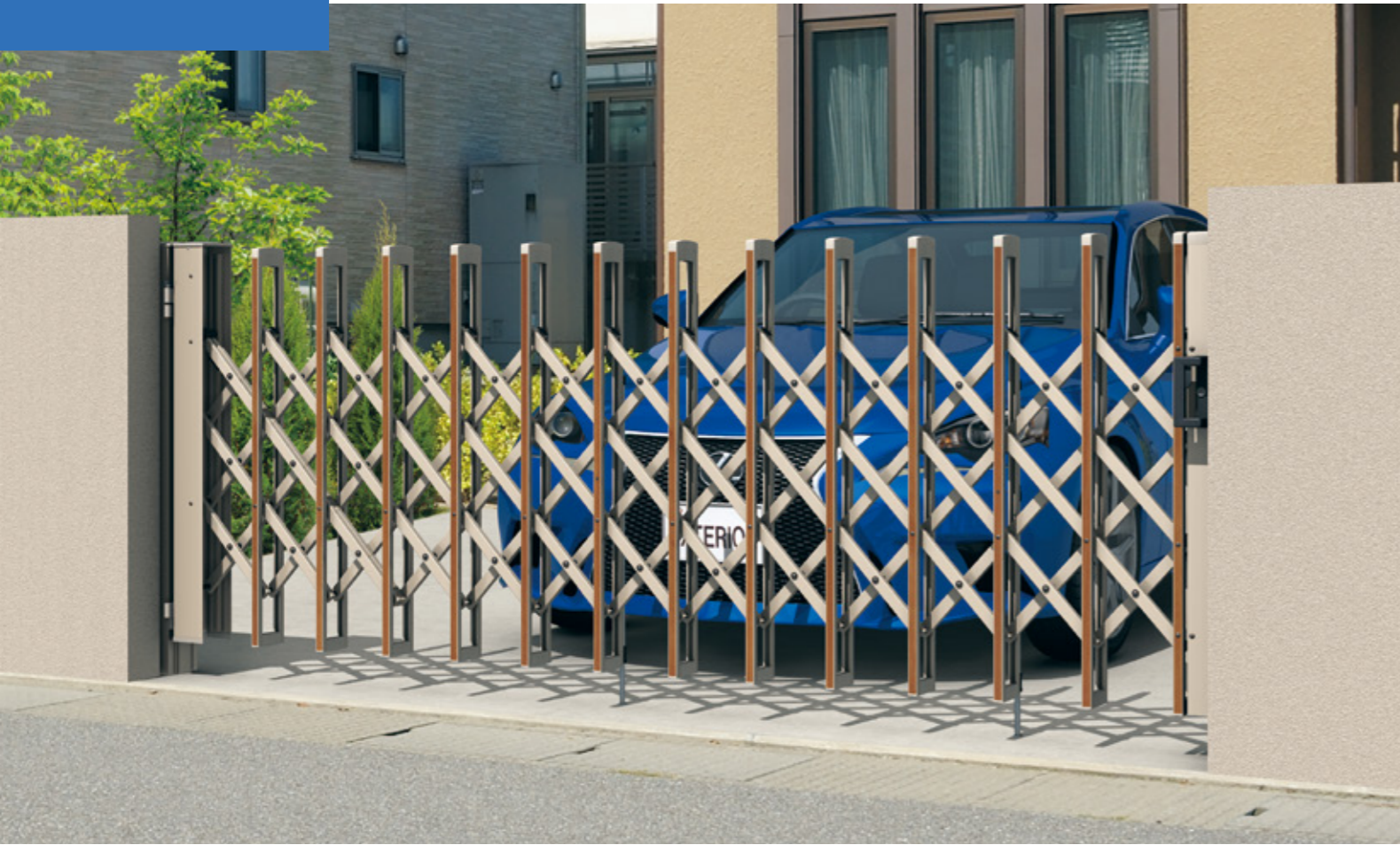

SIZE

Premium Feature: Non-Caster type
Maximum width 4.3m (single gate) and width 8.6m (double gate).

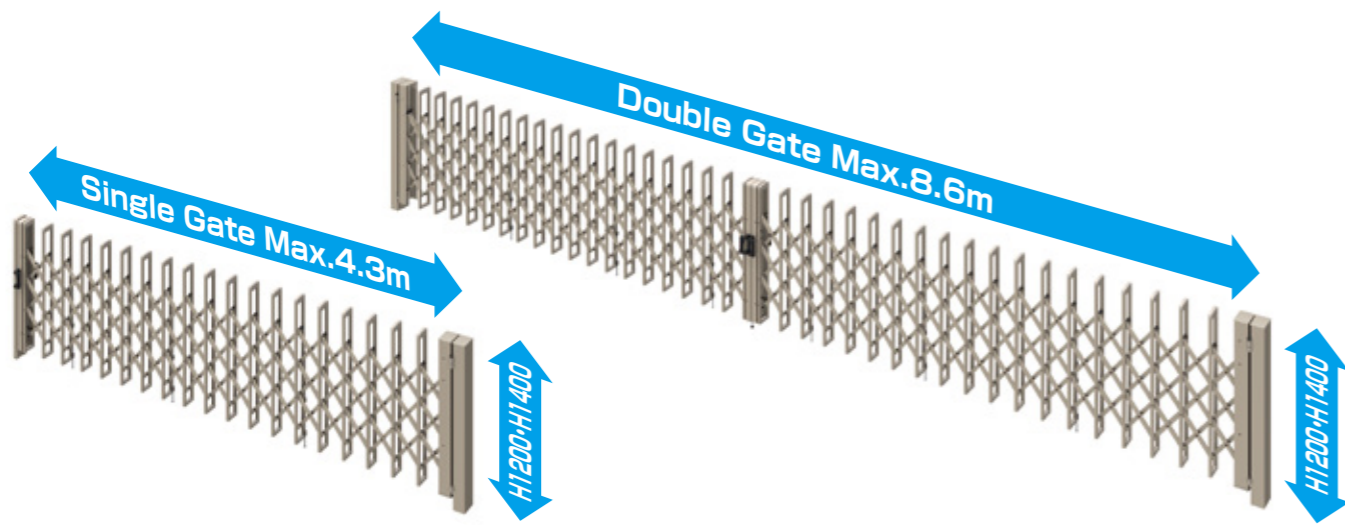

COLOR

aluminium type			laminated type			
SLC Sun Silver	UC Urban Gray	BD Dark Bronze	FA Trad Oak	UC Urban Gray	YC Craft Cherry	UC Urban Gray
			FAU		YCU	

Non-Caster Accordion gates need no tracks or slab adjustments.

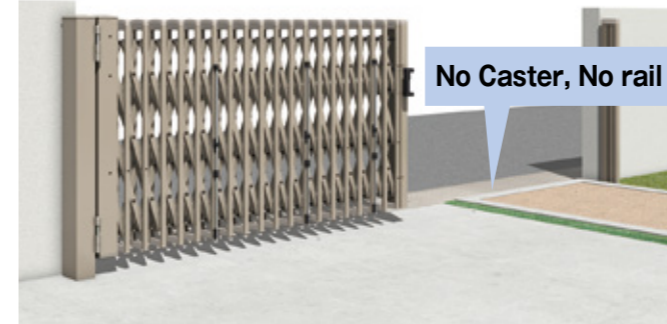

Some Non-Caster Accordion gates can handle a slope up to 5°

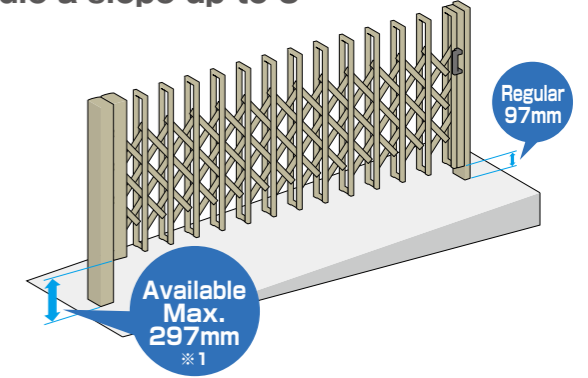

The wider accordion gates (5m/16.4ft for single and 10m/32.8ft for double) have a recessed caster wheel.

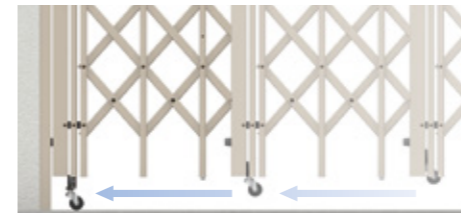

The caster wheel comes out when the gates is fully extended, to support the front end. Easy Docking when closing the gate.

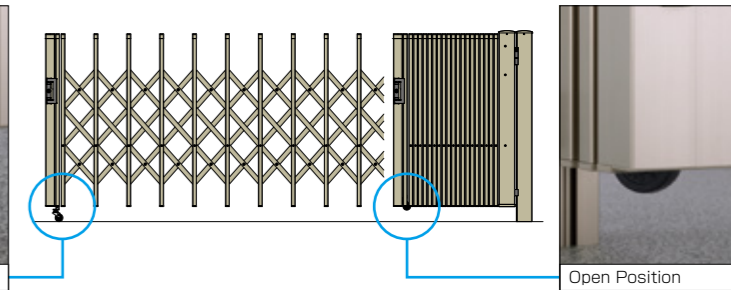

Handle

Universal Design Handle and Easy Operation.
Dimple key helps safety.

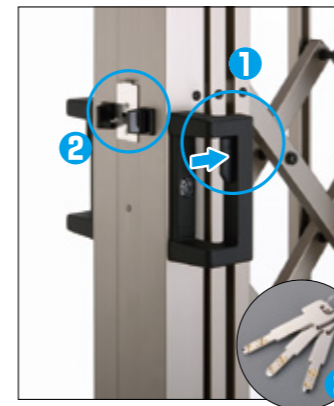

Point

- Grab handle and open in one action.
- Easy Docking when door close.
- Dimple key cylinder helps more safety.

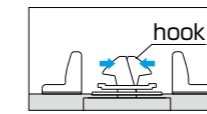

Lock-Down Sticks

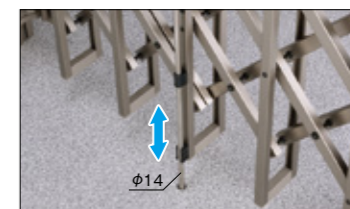

Easy lock & release action. 14mm diameter lock-down sticks helps stabilize the gate.

Plastic Caps installed

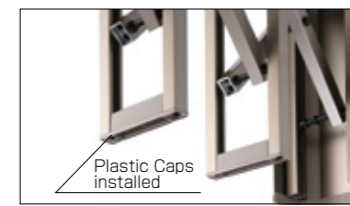

Shake Absorber Latch



Reduce shaking.

HGN-M "Mini Gate" Non Caster Type

